



**BOWERS** GROUP

**baty**



**Venture**  
**FV**

High Accuracy

Image-Based Inspection





# The Baty Venture FV Series

The Baty Venture FV series offers a range of high accuracy, field-of-view inspection machines.

Instant high resolution measurements and user-friendly software.

**Auto Part Recognition**

**Intuitive Software**

**20 Megapixel Camera**

**Split Ring &  
Telecentric LED  
Lighting**



[Visit our Website](#)

For more information please click here



### Instant

- Instant measurements at the push of a button
- Ultra-fast reporting with SPC included
- Character recognition automatically reads & reports individual part numbers during batch measurement
- Hundreds of dimensions in 1 second

### Highly Accurate

- Double telecentric optics for high resolution
- Motorised auto focus
- Auto feature edge detection removes operator influence

### User Friendly

- Simple, intuitive software and user interface
- Automatic measuring and dimensioning
- Auto Import dimensions and tolerances from CAD

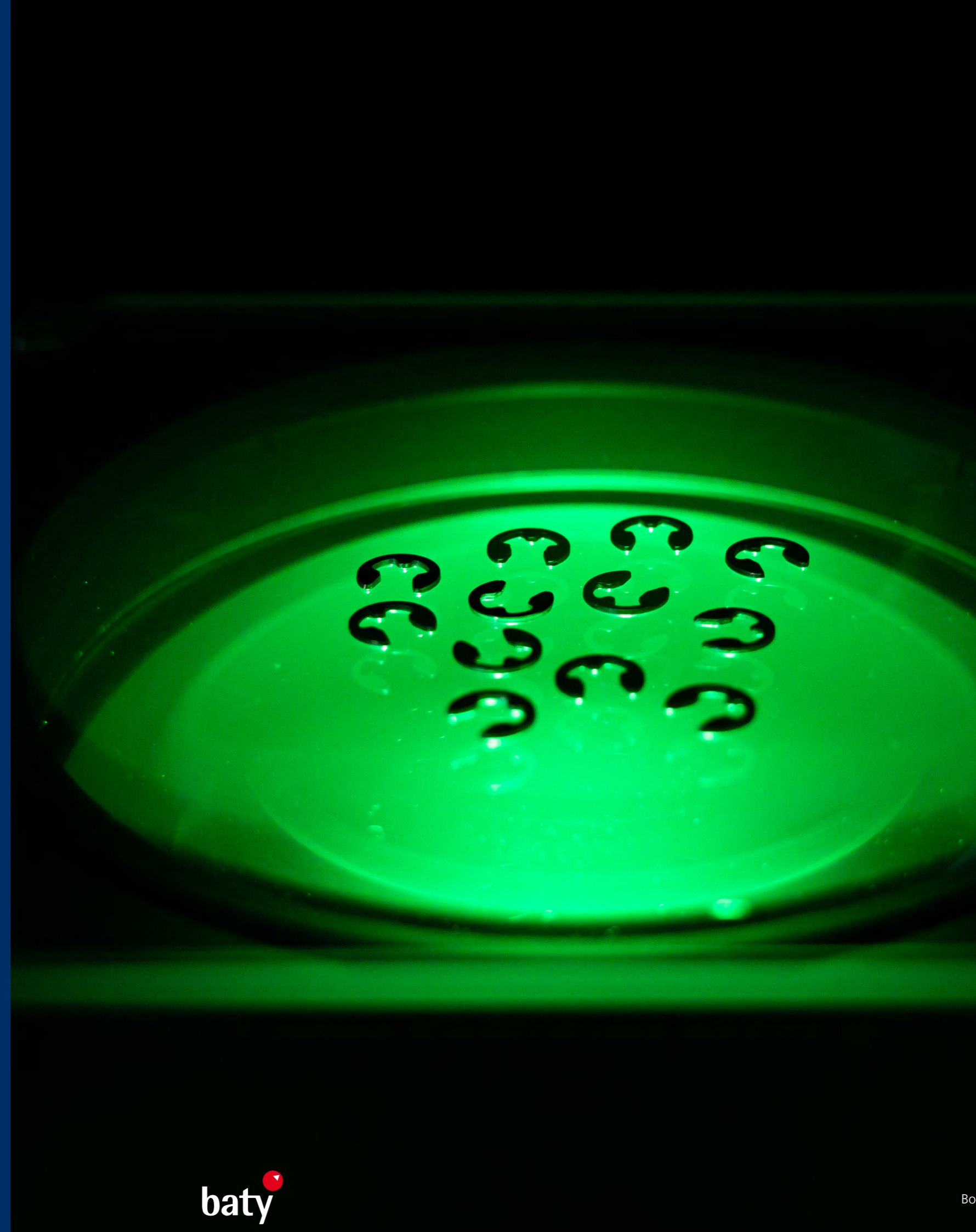

### Easy Batch Measurement

- Single or batch measurements performed in seconds
- Multiple lighting options for surface and profile features
- Intuitive, simple user interface

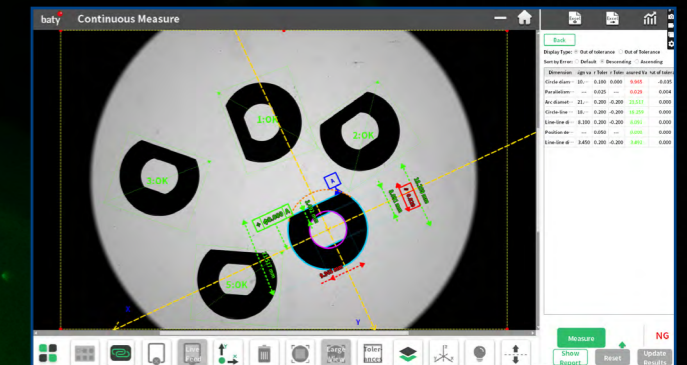

### High Quality Optics

- 20-Megapixel CMOS
- Large telecentric optics
- Newly developed sub-pixel edge detection algorithms

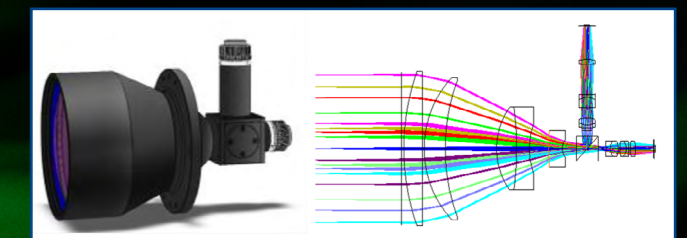
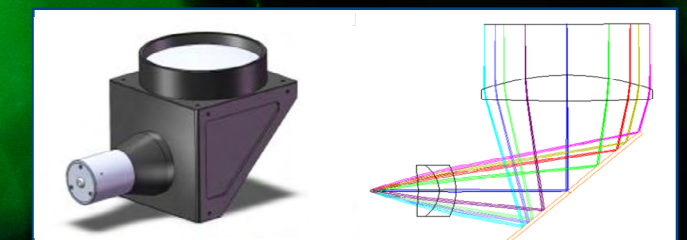

## Ultra Fast Dimensional Measurement

Create instant measurements by simply placing known components randomly on the stage. New parts can be easily measured by automatically extracting features from the scanned image and adding dimensions to create an inspection which is then saved for future use.

Automated part inspection with additional CNC playback for parts larger than the field of view. Fast set up and inspection time to achieve reduced production costs.

## Automatic Part Recognition

No need to select a program or orientate a part with automatic part recognition. The intuitive software will recognise the part, select the inspection program and measure each part in the batch, saving time and eliminating operator error.

## Simultaneously Measure Multiple Parts & Measurements

Quickly and accurately measure hundreds of dimensions on hundreds of parts in seconds using multiple lighting conditions. Instant on screen pass/fail classification for the inspector, with detailed reports automatically saved to your preferred location.

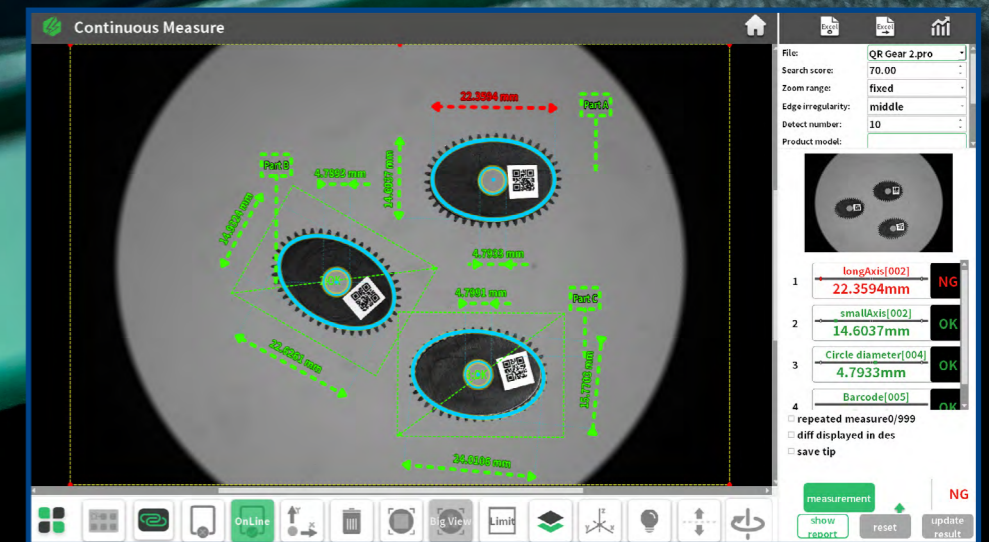
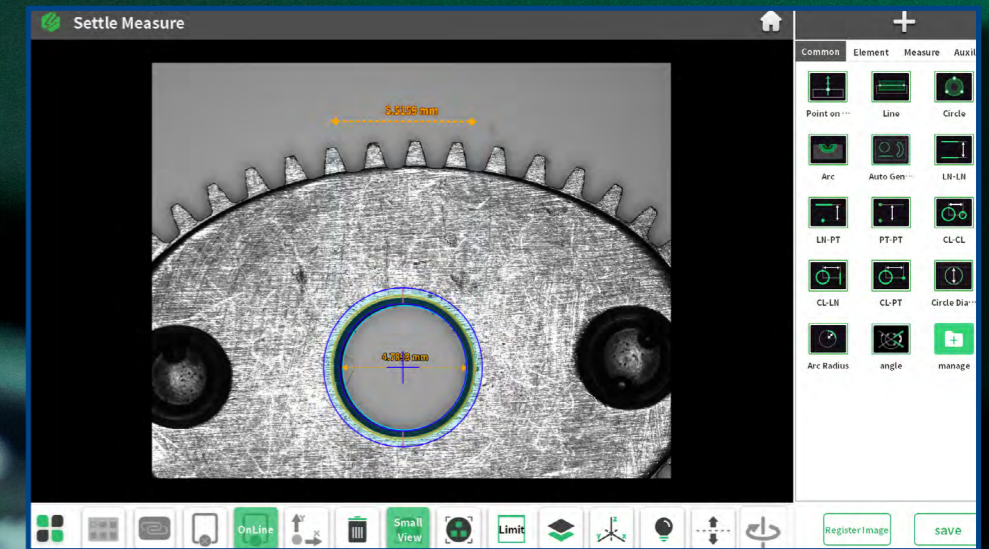

## Large Field-Of-View

Large diameter telecentric optics with motorised auto-focus range of 75mm combined with a measurement area of up to 500x400mm. Motorised split-ring LED ring light, and telecentric profile lighting as standard on all models.

## Programmable Led Ring

### Illumination

Programmable, segmented, split ring LED surface lighting is standard on all FV models. This allows the edges of features to be accurately defined for automatic detection by the software.

The motorised ring light can also be driven in the vertical axis to highlight features with minimal height. In addition, optional Coaxial lighting can be introduced for parts with surface features such as blind bores.

## Automatic Programming From CAD

Create full inspection programs before the part is made. Our 'PROGRAM FROM CAD' feature can import all features, dimensions and their associated tolerances directly from the CAD file. Parts can then be measured and classified as soon as they are placed on the stage.

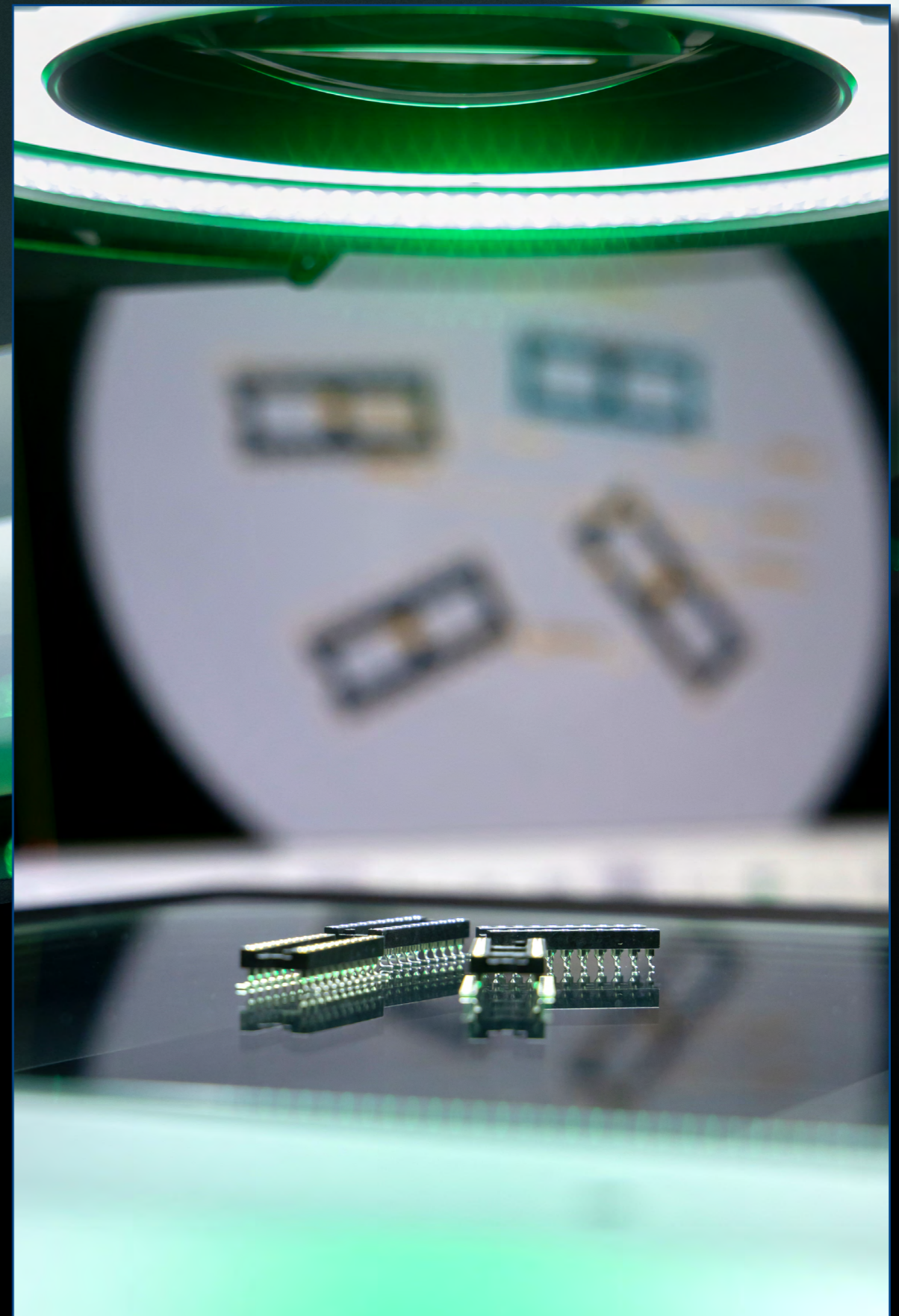
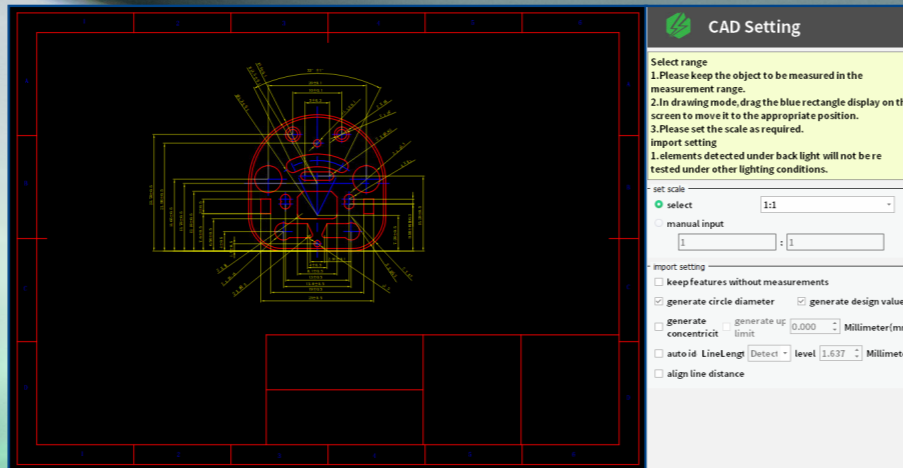

[Visit our Website](#)

For more information please click here

# User Friendly Software

- Simple and intuitive user interface designed with operator in mind.
- Easy to use software allows creation of new inspections quickly and easily with minimal experience.
- Dedicated functions for measuring gears, threads, O rings and springs.
- CAD Import enables user to compare profiles to CAD model.
- Auto-create complete inspections from an imported .dwg file, including dimensions and tolerance information.
- Easy reporting including on screen pass / fail classification.

## Automatic Inspection Reports

A range of Excel compatible reports are immediately available after each inspection, providing measurement data for each measurement including a pass / fail classification. Single part reports include a dimensioned image of the part for easy comparison to the drawing.

Batch inspection results are conveniently compiled into a single batch report. Using character recognition, the software automatically detects identification numbers on each part and then lists the measured results against each part number.

SPC data reports are also included as standard including normal distribution curves and CP, CPK calculations to monitor process capability.

Visit our Website

For more information please click here

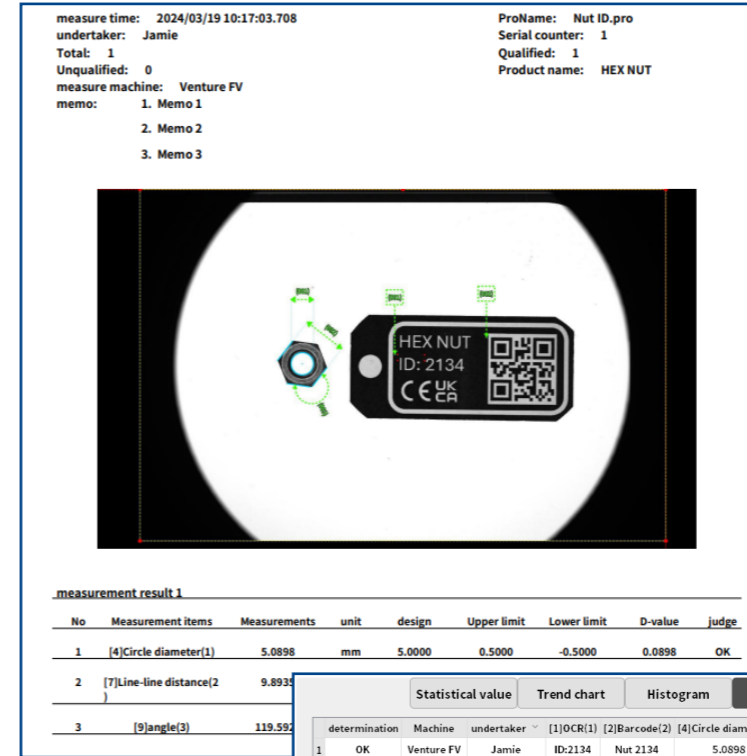
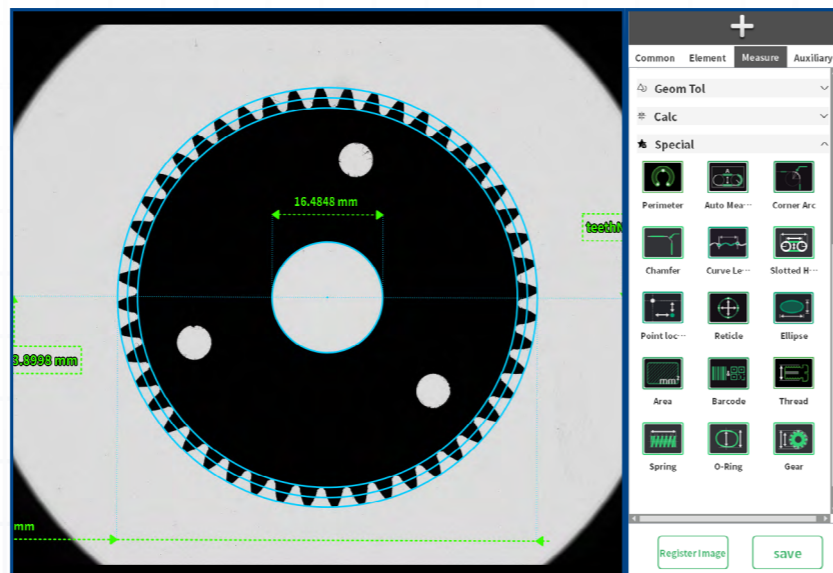
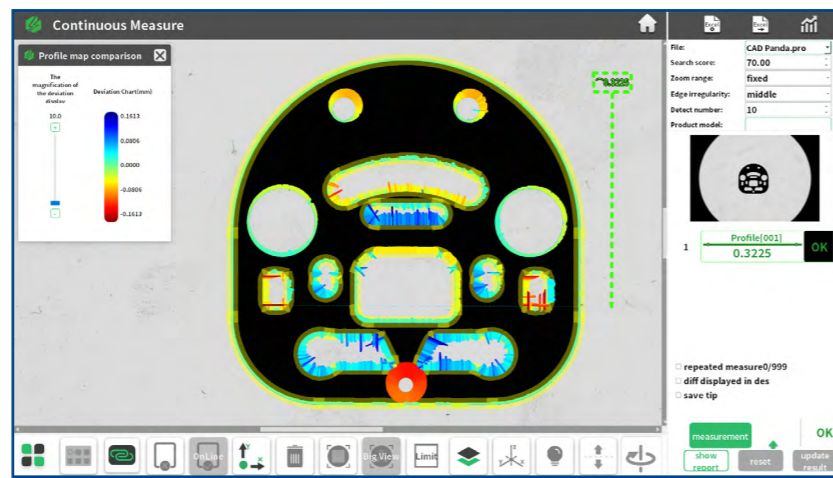

measurement result 1

No	Measurement items	Measurements	unit	design	Upper limit	Lower limit	D-value	judge
1	[4]Circle diameter(1)	5.0898	mm	5.0000	0.5000	-0.5000	0.0898	OK
2	[7]Line-line distance(2)	9.8935						
3	[9]Angle(3)	119.592						

determination	Machine	undertaker	[1]OCR(1)	[2]Barcode(2)	[4]Circle diameter(1)	[7]Line-line distance(2)
1	OK	Venture FV	Jamie	ID:2134	Nut 2134	5.0898
2	OK	Venture FV	Jamie	ID:4321	Nut 4321	5.0492
3	OK	Venture FV	Jamie	ID:1234	Nut 1234	5.0493
4	OK	Venture FV	Jamie	ID:6789	Nut 6789	5.0924
5	OK	Venture FV	Jamie	ID:9876	Nut 9876	5.0915
6	OK	Venture FV	Jamie	ID:7698	Nut 7698	5.0924

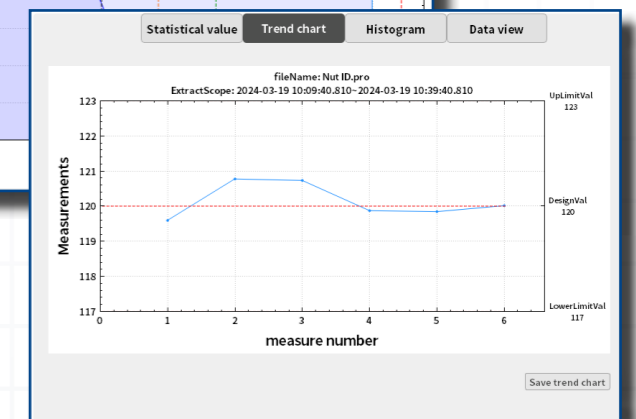
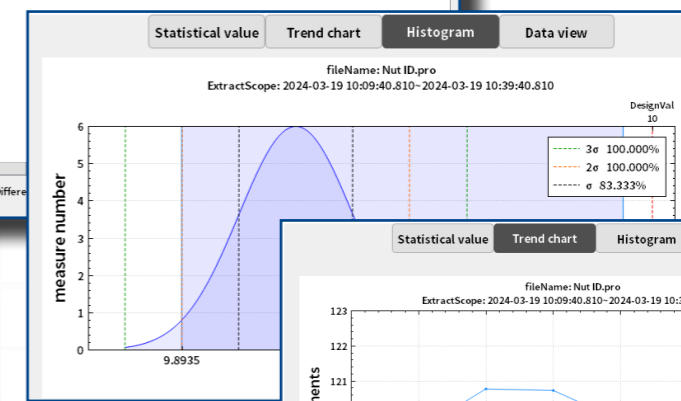

# Stable & Robust Construction

The high precision, CNC work stage utilises heavy duty cross-roller rail guides for optimum performance and accuracy.

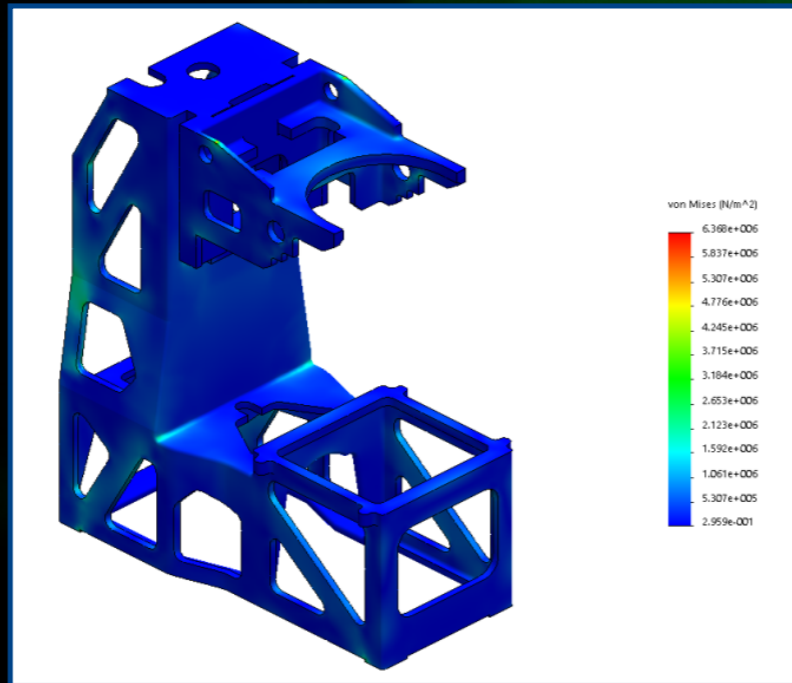

The heavy duty chassis casting provides a stable foundation for the substantial motorised X-Y measuring stage. Ensuring correct alignment is maintained to the motorised focus and lighting axes.

[Visit our Website](#)

For more information please click here



## Optional Coaxial Lighting

Coaxial lighting enables a crisp high resolution image to be achieved on all surface features, even at the bottom of a blind bore or taper. This option is available on all models.

# Confocal Probe

The optional **SB-FVHPS-1** confocal laser probe enhances the FV 3020 and FV 5040 models with 3D measurement capabilities. Its non-contact Z-axis measurements work across various surfaces, including transparent materials, outperforming traditional touch probes.

This technology is ideal for assessing surface height, flatness, and thickness.

Another significant advantage is the ability to measure transparent material thickness from a single side. The probe achieves this by simultaneously capturing data from the top and bottom surfaces, making it an efficient and versatile solution for diverse measurement needs.

# Rotary Axis

The optional rotary axis is an affordable CNC rotary indexing axis that adds rotational capability to automated inspection programs. It allows cylindrical parts to be rotated and measured multiple times per revolution.

Programming rotation intervals is straightforward using the rotary control panel, enabling precise angle adjustments.

This system also supports unique lighting conditions for each rotation, ensuring accurate measurements of both surface and profile features. Its versatility makes it an efficient tool for inspecting complex cylindrical components.

[Visit our Website](#)

For more information please click here

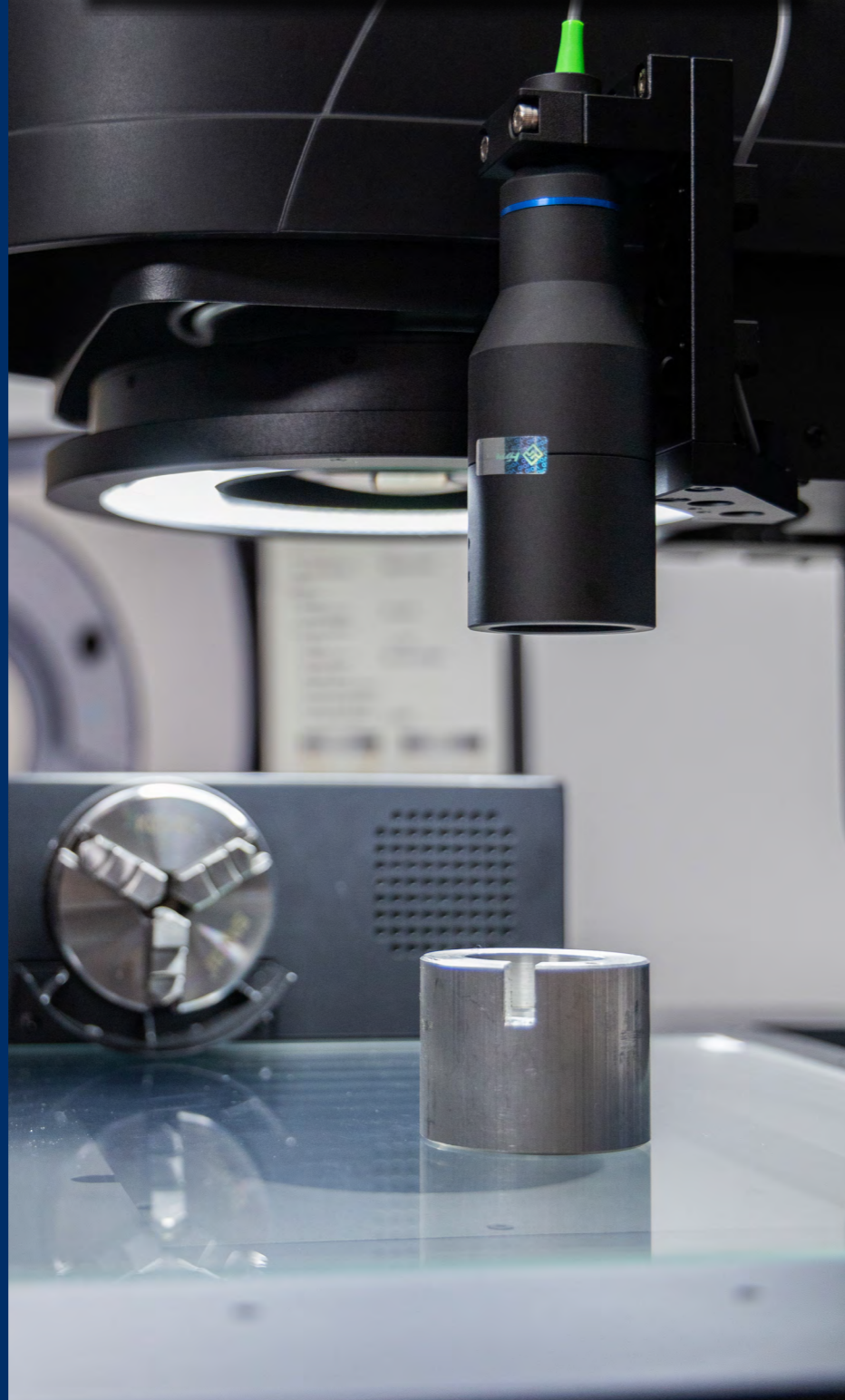
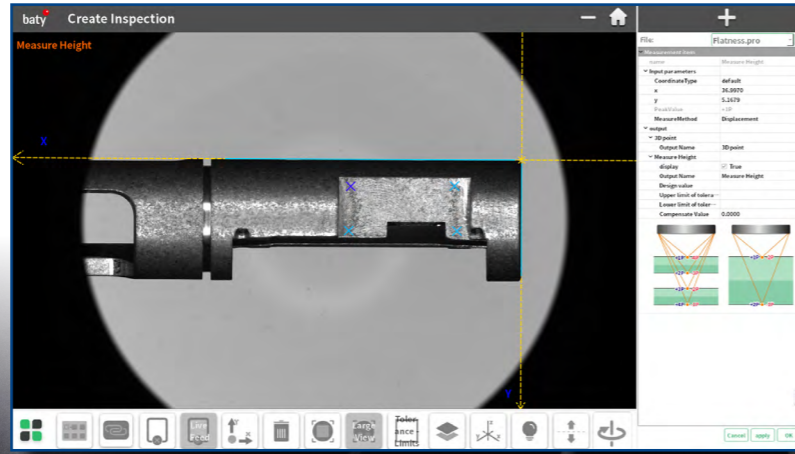

## Confocal Probe Key Features

- High accuracy: 2.5µm
- Precision spot size: 65µm for measuring tiny surface points
- Suitable for a wide range of materials, including transparent

Confocal Probe Specification	SB-FVHPS-1
Probe Stand off Distance / Vertical Measuring Range (mm)	68.5 +/- 8mm
FV3020 XYZ Measurement Volume (mm)	95 x 115 x 70
FV5040 XYZ Measurement Volume (mm)	275 x 330 x 250
Accuracy (µm)	2.5
Static Repeatability (µm)	0.35
Light Spot Diameter (µm)	ø 65



## Rotary Axis Key Features

It allows cylindrical parts to be rotated and measured multiple times per revolution to evaluate:

- Roundness
- Concentricity with other diameters
- Cylindricity
- Run out

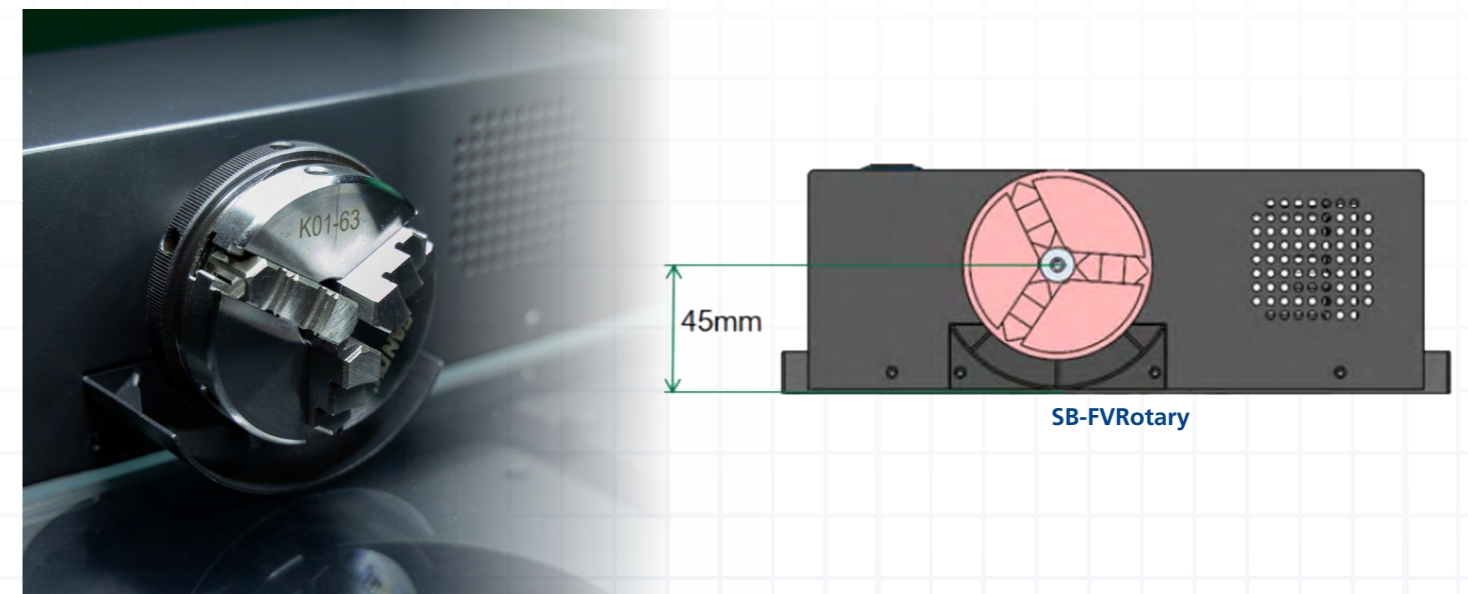



## FV-3020 Standard Features

- 300 x 200 dual field machine
- Ø100 x 80mm / 25 x 20mm field of view
- 3µm / 1µm accuracy
- Standard programmable lighting:
  - Telecentric LED profile (white)
  - 4 zone medium and low angle surface ring light (white)
  - High angle motorised surface ring light (green)
- Intuitive, easy to use software
- Immediate PASS / FAIL classification and PART GRADING function
- Optical Character Recognition (OCR) function captures piece part serial numbers
- Detailed reporting options including SPC



## Optional Features

- Coaxial surface lighting
- Program from CAD
- Confocal Probe
- Rotary axis

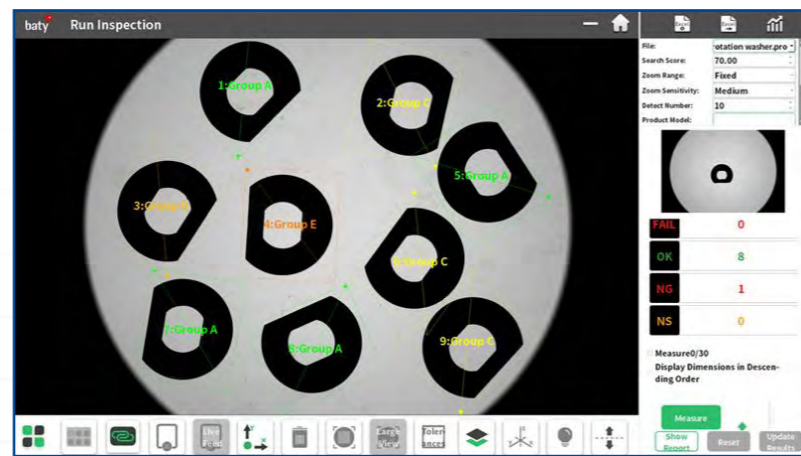

Part Grading

[Visit our Website](#)

For more information please click here

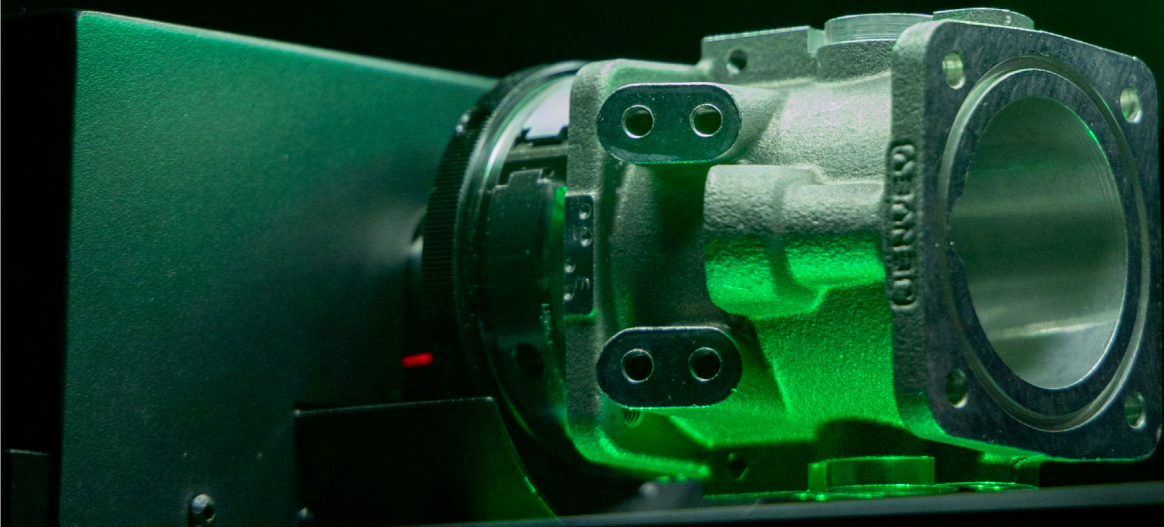

The Baty FV model range design is based either on our Ø100mm, or Ø150mm low distortion telecentric lens.

Both lens types can be configured for either single field or dual field applications. The result, when combined with our range of precision work stages, is a range of machines to suit every application.

Every model in the FV range is a Vertical light path system and includes:

- CNC Auto-focus
- Programmable LED surface and profile lighting
- Supplied complete with Fusion FV software, PC and 27" monitor, keyboard and mouse



Options include:

- Confocal sensor
- Motorised rotary axis
- Coaxial lighting
- Program from CAD
- 3D structured light sensors

[Visit our Website](#)

For more information please click here

FV Specification			FV-1080	FV-1080D	FV-1511	FV-2020	FV-2113P	FV-3020
								
			Single Field Fixed Stage	Dual Field Fixed Stage	Large FOV Dual Field Fixed Stage	Dual Field 200 x 200 CNC Stage	Dual Field High Precision CNC Stage	Dual Field 300 x 200 CNC Stage
Measurement Range (mm)	Combined Range	Large Field	-	-	-	200 x 200	210 x 130	300 x 200
		Large Field with Coax Light	-	-	-	145 x 200	-	245 x 200
		Small Field	-	-	-	130 x 130	200 x 100	230 x 130
	Field of View	Large Field	Ø100 x 80	Ø100 x 80	Ø150 x 110	Ø100 x 80	25 x 17	Ø100 x 80
		Large Field with Coax Light	25 x 80	25 x 80	50 x 100	25 x 80	25 x 17	25 x 80
		Small Field	-	20 x 16	50 x 35	20 x 16	8 x 5	25 x 20
Accuracy (µ)	Combined Range	Large Field	-	-	-	± (5+L/50)	± (4+L/50)	± (5+L/50)
		Small Field	-	-	-	± (3+L/50)	± (2.7+L/50)	± (3+L/50)
	Field of View	Large Field	± 3	± 3	± 5	± 3	± 2	± 3
		Small Field	-	± 1	± 2	± 1	± 0.7	± 1
Image Sensor			20 Mega-pixels		12 Mega-pixels		20 Mega-pixels	
Illumination System	Profile		Telecentric LED					
	Surface 1		4-zone medium and low angle ring light (white LED)					
	Surface 2		Ring Illumination (green LED)					
	Surface 3 (optional)		Episcopic coaxial (white LED)					

FV Specification			FV-3021	FV-5040	FV-5040D
					
			Large FOV Dual Field	Single Field Moving Stage	Dual Field Moving Stage
Measurement Range (mm)	Combined Range	Large Field	300 x 210 (R75 x 4 corners)	500 x 400	500 x 400
		Large Field with Coax Light	200 x 210	500 x 400	500 x 400
		Small Field	200 x 135	-	430 x 350
	Field of View	Large Field	Ø150 x 110	92 x 62	92 x 62
		Large Field with Coax Light	50 x 100	92 x 62	92 x 62
		Small Field	50 x 35	-	20 x 15
Accuracy (µ)	Combined Range	Large Field	± (7+L/50)	± (5+L/200)	± (5+L/200)
		Small Field	± (4+L/50)	-	± (3+L/200)
	Field of View	Large Field	± 5	± 3	± 3
		Small Field	± 2	-	± 1
Image Sensor			12 Mega-pixels		12/20 Mega-pixels
Illumination System	Profile		Telecentric LED		
	Surface 1		4-zone medium and low angle ring light (white LED)		
	Surface 2		Ring Illumination (green LED)		
	Surface 3 (optional)		Episcopic coaxial (white LED)		



The all-new Venture FH models are Horizontal light path systems, often better suited to small 3 dimensional, or cylindrical parts.

FH models feature a fixed or a rotating workstage and the same intuitive Fusion FV software. Parts can be placed either directly onto the stage surface or into suitable work-holding.

## FH-1080

Featuring a fixed or a rotating workstage, parts can be placed either directly onto the stage surface or into suitable work-holding.

- Fasteners (incl. threads)
- Connectors
- Cutter profiles
- Tool offsets
- Shoulder radii
- Threads
- Micro tool applications
- Implants

## FH-1080AF

The AF model features additional programable surface ring lighting, autofocus and a CNC rotating workstage. This allows features on different sides of the part to be measured in the same automated inspection.

Cylindrical parts may be rotated, allowing multiple measurements at fixed angular intervals to measure:

- Average diameter
- Roundness
- Concentricity
- Through-hole position
- Radial pockets

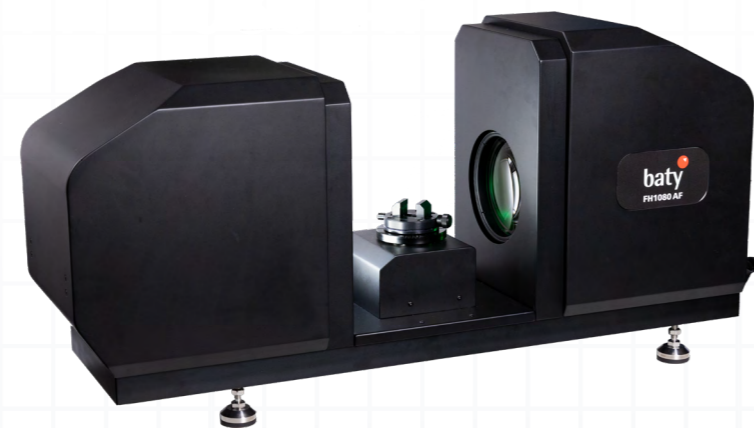
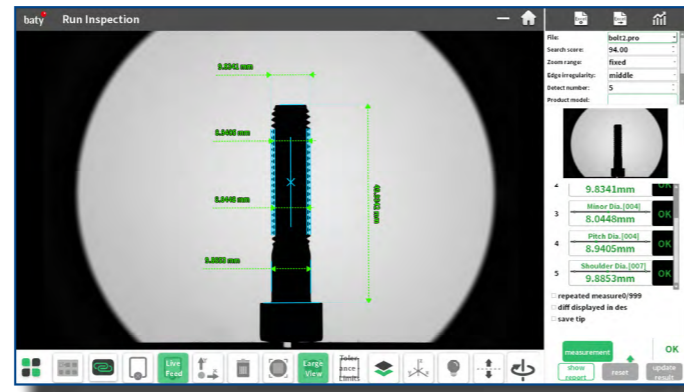

The FV1080's fixed workstage platform allows parts to be placed for immediate measurement.

Standard work holding accessories are available including the self centering vice the dual axis Vee block. These accessories locate into the stage platform via a central pivot location for ease of use.

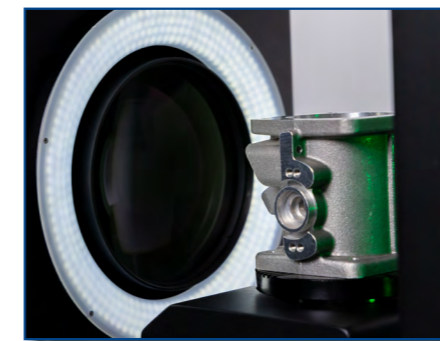
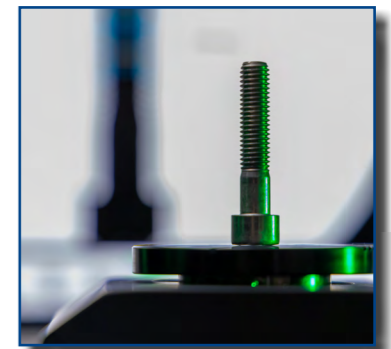
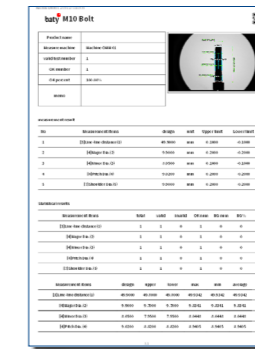

The combination of surface lighting, autofocus and rotary control allows surface features on different planes to be measured in a single shot

- Multi-faceted parts
- Chamfers and counter bore
- Milled features
- Fastener head details

FH Specification	FH-1080	FH-1080AF
		
Measurement Range (mm)	Ø100 x 80	Ø100 x 80
Accuracy	± 3	± 3
Repeatability	± 1	± 1
Travel (mm)	n/a	n/a
Optical	Large field telecentric, low distortion lens	
Image Sensor	20 Mega Pixels	
Illumination System	Profile	Telecentric LED
	Surface 1	n/a
Autofocus	n/a	Yes
Focus Travel	n/a	75mm
Dimensions (mm)	790 x 230 x 385	790 x 230 x 385
Weight (kg)	27	27
Max. Load (kg)	3	3
Environmental Spec	20°C ± 2°C, relative humidity: 30% - 80%, vibration: <0.02g, <15Hz	
Voltage	220V, 50Hz, 600W	

[Visit our Website](#)

For more information please click here



## Find Out More

To find out more about the Venture FV series including return on investment, please contact:

E: [sales@bowersgroup.co.uk](mailto:sales@bowersgroup.co.uk)

W: [www.bowersgroup.co.uk/contact-us](http://www.bowersgroup.co.uk/contact-us)

T: +44 1276 469866

## Comprehensive Service & Support

To find out more about the Venture FV series including return on investment, please contact:

E: [service@bowersgroup.co.uk](mailto:service@bowersgroup.co.uk)

W: [www.bowersgroup.co.uk/contact-us](http://www.bowersgroup.co.uk/contact-us)

T: +44 1276 469866

**FVBROCHURE\_25\_ISSUE01**

Visit our Website

For more information please click here

